



EGS Collab Experiment 2

Distributed temperature (DTS) system



BERKELEY LAB

Technical report
LBNL EESA
September 2022

AUTHOR (Last, First):

Hopp, Chet

DATE:

11-8-2022

TITLE:

EGS Collab Experiment 2: Distributed fiber optic temperature system

Contents

1	Terminology	4
2	Introduction	5
3	Installation	6
4	Data	11
4.1	Raw data	11
4.2	Location mapping	11
4.3	Processed dataset	12
4.4	Calibration bath issues	13
5	Results	16
5.1	Joule-Thomson effect at fracture intersection points	16
5.2	Cooling of monitoring boreholes during chilled water circulation	20
5.3	Data access	21

1 Terminology

- **DTS:** Distributed Temperature Sensing. A form of Distributed Optical Fiber Sensing (DOFS) that uses the Raman component of backscattered light along the length of a fiber to measure temperature.
- **DFOS:** Distributed Fiber Optic Sensing. A family of methods used to interrogate lengths of fiber using backscattered light.
- **SURF:** Sanford Underground Research Facility. The old Homestake gold mine in Lead, SD, USA where the EGS Collab experiment has taken place.
- **OD:** Outer diameter
- **ID:** Inner diameter
- **ERT:** Electrical Resistivity Tomography
- **GDR:** Geothermal Data Repository.

2 Introduction

The EGS Collab Experiment #2 took place from approximately February–September 2022 at the Sanford Underground Research Facility in Lead, SD. The project was the continuation of a years-long experiment aiming to validate models of enhanced geothermal systems through a series of high-pressure injections into rock between 1200 and 1500 meters below the surface. These injection experiments were extensively monitored by a number of systems including seismic waveform recording, pressure and temperature probes, active source seismic tomography, electrical resistivity tomography, and a full suite of DFOS interrogators.

This report details the Distributed Temperature Sensing (DTS) system, which uses Raman back-scattered light from a forward-propagating laser pulse to measure the temperature along the length of a multi-mode fiber optic cable. For details on this method, the reader is referred to [1].



Figure 1: Silixa XT-DTS unit used to collect the measurements reported here.

3 Installation

The sensing fiber (manufactured by NBG of Germany) was installed as a continuous loop in four monitoring wells. The fiber package comprised six individual fibers, two multi-mode and four single-mode, encapsulated in a 2.2 mm OD stainless steel casing. The casing was coated in high-density polyethylene and the entire package had a manufacturer-reported minimum bend radius of 25 mm.

The entire ~ 720 m continuous fiber loop was installed in four 96 mm ID boreholes behind 73 mm OD centralized PVC casing (Figure 4). The ~ 11 mm annulus space was shared with electrodes used for electrical resistivity tomography (ERT). Additional instrumentation was installed inside the PVC casing and then each of the holes was filled with a specially formulated grout to couple all of the instrumentation to the rock.

Figure 5 shows a simplified schematic of the layout of the fiber loop, while Figure 2 shows the location of the boreholes and seismic sensors in the Experiment 2 testbed. The fiber package was installed as one continuous piece, meaning that there are no breaks or splices in the loop. The free ends of the loop returned to the same location at Site A (black boxes in Figure 2) of the experiment where the individual fibers were spliced to jumper cables that were then connected to the various interrogator units, all of which resided either in weather-tight steel enclosures or on tables near the intersection of the Site A and the main drift. Two water baths were also located at this location. One was maintained at roughly 40 degrees C, the other was left at ambient temperature. A length of the fiber package (between 15 and 30 m) was coiled and placed into each of these water baths. The package passed through each bath once on its way from the interrogator to borehole AMU and again on its way from borehole DML back to the interrogator (for a total of two coils of cable in each bath). See Figure 5 for an illustration of the installation.

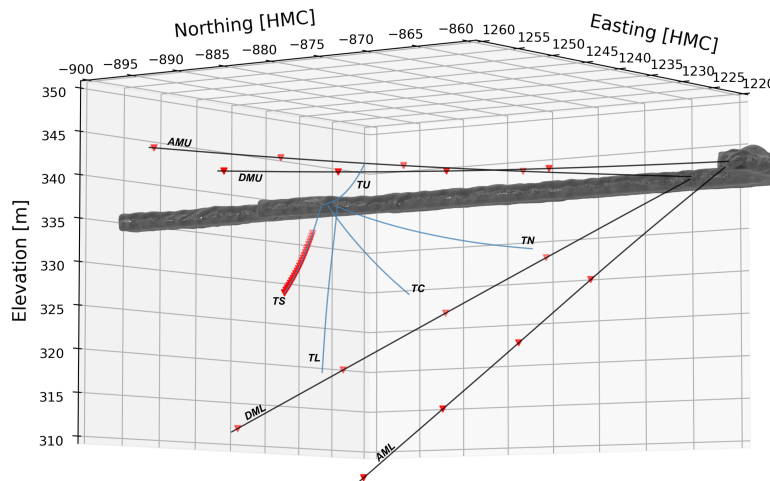
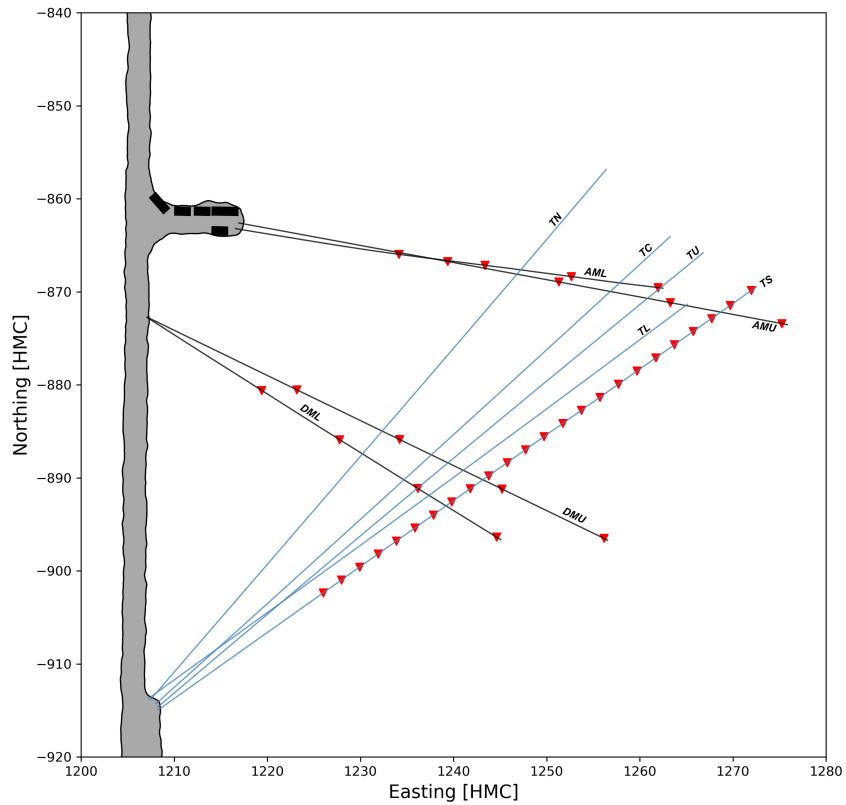

Figure 2: Overview of the EGS Collab Experiment 2 testbed on the 4100 level of SURF. The boreholes are labeled by name and the locations of the seismic sensors are indicated with red triangles. The fiber loop is installed in the four grouted boreholes (AMU, AML, DMU, and DML) shown in black. A string of hydrophones is installed in non-grouted borehole TS.



Figure 3: Interior of the hot water calibration bath showing the submersible heater (black) placed into the interior bath containing the fiber loop. This smaller bath was filled with water, capped, and then the entirety of the larger tub was filled with bubble wrap that acted as insulation.

The DTS interrogator used for EGS Collab (Experiments 1 and 2) was a Silixa XT-DTS system (Figure 1). Each end of one of the multi-mode fibers was connected to the XT-DTS. This so-called ‘double-ended’ (the fiber is interrogated in both directions) configuration takes longer to make a single measurement than a single-ended setup but results in a more accurate, stable data product. The two water baths were used for temperature calibration with one bath maintained at ~ 40 °C using an electric, submersible heating element (Figure 3) and the other bath remained at ambient mine temperature. The XT-DTS was connected to two thermistors that were used to continuously record the temperature in each bath and anchor the temperature sensed by the fiber in the baths to the temperature measured by the thermistors.

For the duration of the experiment, measurements were taken every 10 minutes with a spatial resolution (spacing of measurements along the fiber) of 0.254 m.

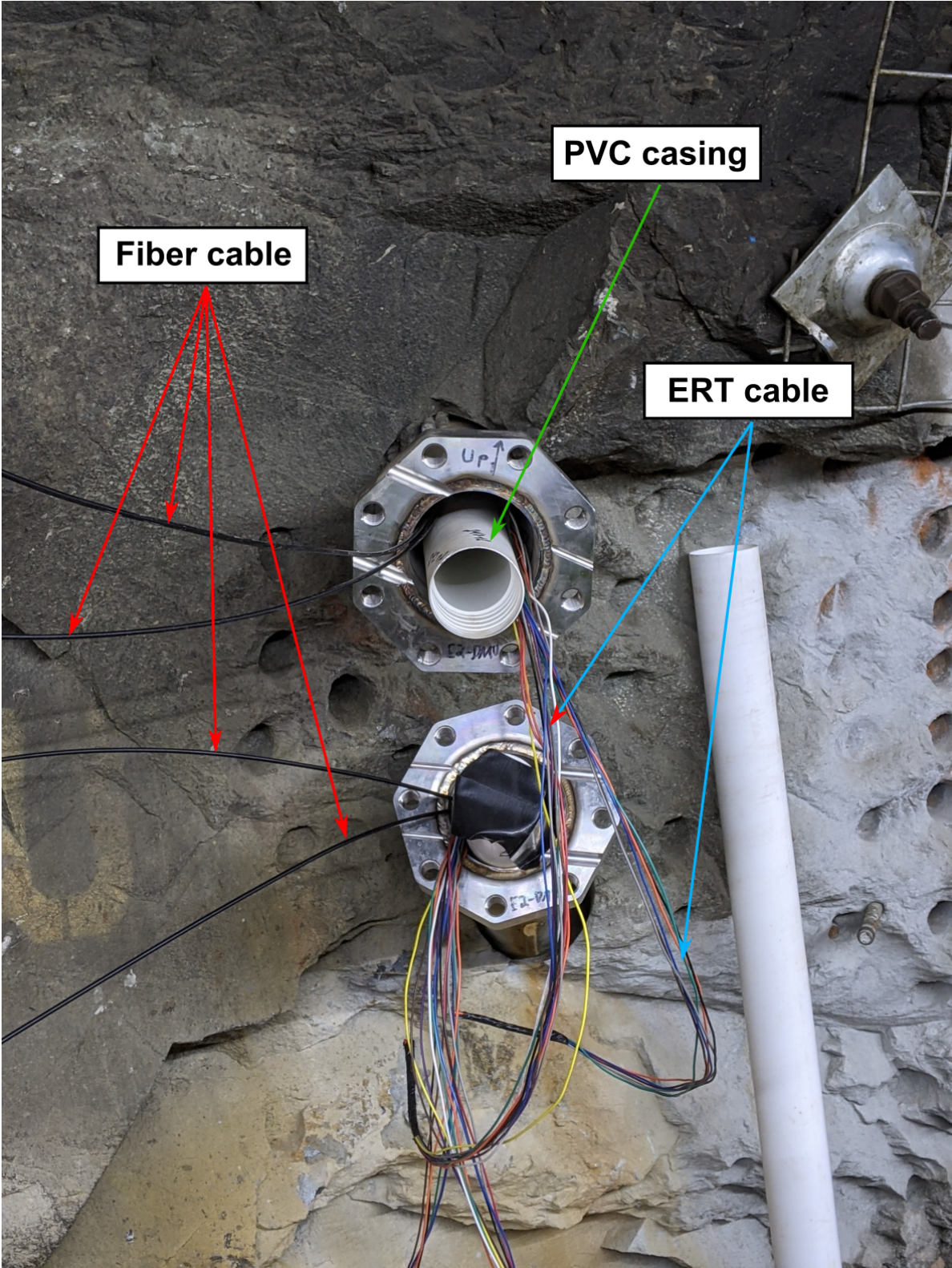

Figure 4: Two grouted monitoring wells (AMU and AML) after installation of the PVC casing, ERT electrodes, and fiber optic package. The wells were later capped and grouted.

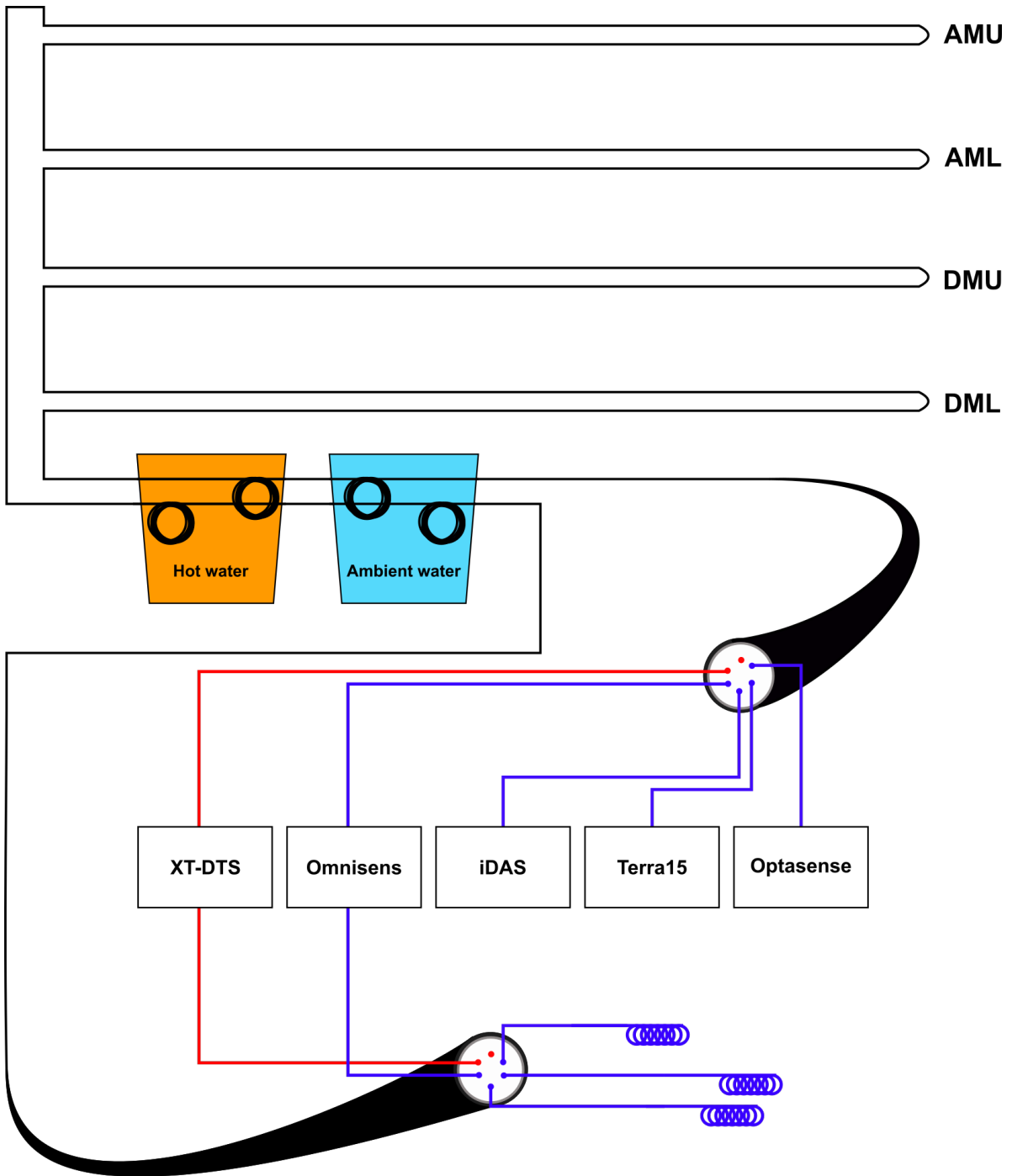

Figure 5: Generalized layout of the entire fiber optic sensing system. Each of the four single-mode fibers (blue) was connected to a different DAS or DSS interrogator, while only one of the multi-mode fibers (red) was connected to the XT-DTS temperature sensing unit. The final MMF was not used.

4 Data

This section describes the data products produced by the XT-DTS interrogator box and provides useful context for users.

4.1 Raw data

The data recorded by the XT-DTS is saved as single XML files. Each file contains the data for all points along the fiber for a single measurement in time. There are six columns of data in each of the files:

- Length along fiber (LAF) in meters
- Stokes intensity (ST)
- anti-Stokes intensity (AST)
- reverse Stokes intensity (REV-ST)
- reverse anti-Stokes intensity (REV-AST)
- DTS temperature (TMP) in degrees C

The four columns of Stokes intensity are measurements of the intensity of the Raman component of backscattered light at each point along the fiber and are used by the box to calculate the temperature at that point. This calculation makes a number of assumptions about the fiber itself and the relationship between Stokes intensity and temperature and is done internally. If the user wishes to apply a different algorithm to temperature calculation they may do so using these columns. In most cases, the user will be interested in only the distance along fiber and the temperature in degrees C columns (the first and last, respectively).

4.2 Location mapping

In order to turn the lengths along fiber recorded by the XT-DTS to meaningful coordinates relative to the boreholes in the experiment, an effort was made to “map” the points at which the fiber package entered and exited each borehole. To do this, we heated the entry and exit points with a heat gun for a period of roughly 1 minute. We did this in two steps, one for boreholes AMU and AML and the other for DMU and DML. The resulting spike in temperature is visible at 14:29 UTC for AMU/AML and at 14:09 UTC for DMU/DML, both on 2022-9-12. This corresponds to the filenames `channel 1_20220912141411046.xml` and `channel 1_20220912142413359.xml`, respectively, in the raw data. The mapping is shown in the table below:

Borehole	Entry point [m along fiber]	Exit point [m along fiber]
AMU	85.70	207.19
AML	221.67	343.69
DMU	384.37	495.44
DML	505.10	616.43

4.3 Processed dataset

We applied the mapping above to the raw data set to extract only the portions of the data pertaining to the boreholes, omitting any data from portions of the fiber package that were hanging in the drift, or spooled in the water baths. We refer to this as the ‘processed’ dataset.

The processed data come as four files, one for each monitoring borehole in the 4100 testbed. The data span the period of 3-14-2022 to 9-14-2022, including all of the stimulations and flow tests that took place throughout the course of EGS Collab Experiment 2.

Each file is formatted as NetCDF: <https://www.unidata.ucar.edu/software/netcdf/> which is a self-describing binary file format. It originated in the geosciences and is used for array-based measurements, especially in atmospheric science.

Most major programming languages have an interface for NetCDF I/O, but the files here were written using the `xarray` Python package: <https://xarray.pydata.org/en/stable/index.html>

Therefore, if the user is working in Python, I recommend reading the files with `xarray` as follows (assuming `xarray` is installed in your path):

```
import xarray as xr
ds = xr.open_dataset('path-to-file')
```

This will read the data in as an `xarray Dataset`, which is a container for multidimensional, labeled data: <https://xarray.pydata.org/en/stable/data-structures.html>

As mentioned in the Installation section, each borehole contains a single loop of fiber optic cable. We have split each borehole into a ‘downgoing’ and an ‘upgoing’ section where the downgoing is the closest to the start of the cable and the upgoing the furthest (although the ‘start’ or ‘end’ of the cable is essentially arbitrary). The temperature data (in °C) are represented in the `Dataset` as two `DataArrays` named `down_data` and `up_data` respectively, where the ‘values’ attribute is a 2-dimensional `numpy` array of measurements. Each row corresponds to a single channel of data (i.e. a single point along the fiber) and each column corresponds to a single measurement in time.

If you’ve read in the data following the snippet above, you can plot them as follows:

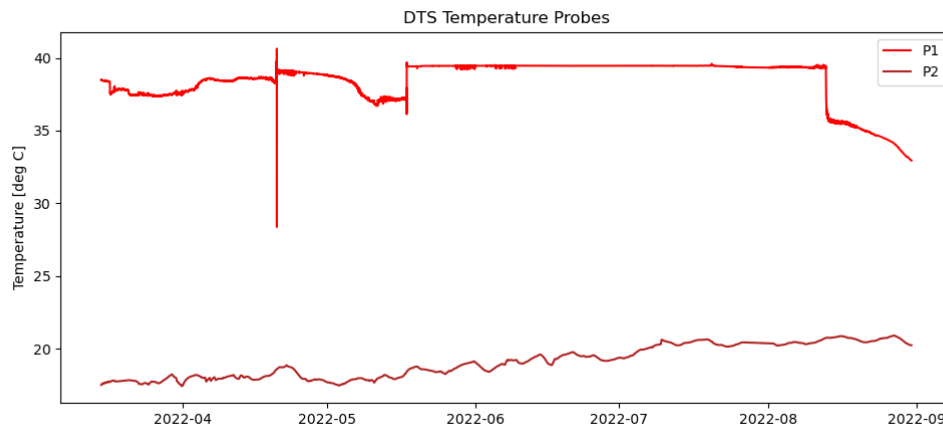

Figure 6: Time series plots of the two temperature probes in either of the water baths used for XT-DTS temperature calibration.

```
import matplotlib.pyplot as plt
ds["up_data"].plot()
plt.show()
```

4.4 Calibration bath issues

There is one important issue with these data that the user needs to be aware of before processing and interpreting results. As detailed in the Installation section above, the temperatures recorded in the raw and processed data are calculated by the XT-DTS using a calibration via two temperature probes placed in the two water baths. To reiterate, there is a length of fiber (>10 m) in each bath and this exact length is known to the XT-DTS. The XT-DTS then uses the known temperature of the water from the probe, which should be the same as the temperature of the fiber in the bath, to calibrate the temperature sensed along the entire fiber length. Unfortunately, the hot water bath (maintained at 40°C) slowly evaporated with time and needed to be refilled periodically. This meant that, at times, the temperature probe was measuring air temperature in the bath, while the fiber was still submerged. The exact effect of this discrepancy is unknown as oftentimes no one was underground to refill the bath or observe the position of the temperature probe relative to the water level. It is also difficult to know what the temperature of the water (and therefore fiber) was as the water level dropped because the circulation heater did not reach all the way to the bottom of the bath and was attempting to maintain 40°C even when not fully submerged.

Figure 6 shows the temperature measured by the XT-DTS temperature probes in the hot (P1) and ambient (P2) temperature water baths with time. The long period of stable temperature in the hot water bath corresponds to a period of stable water level. This also

coincides with the start of the circulation tests being conducted as part of EGS Collab Experiment 3. Deviations from this stable trend represent issues with the water level and probably a discrepancy between the temperature being measured by the probe (colder) and the temperature to which the fiber package in the bath was subjected (warmer). This would produce an apparent, and incorrect, cooling across the entire fiber. The ambient temperature water bath simply tracks the temperature in the drift that, in turn, is a damped measure of the air temperature at the surface, which is used to ventilate the mine. This trend is consistent with a general warming of the air in South Dakota from March until September.

We applied a simple correction for this bath-related apparent temperature variation, which we made available as a ‘corrected’ dataset on the GDR. The ‘processed’ and ‘corrected’ data are otherwise the same. To apply the correction, we assumed that each channel was affected equally by the calibration bias and attempted to remove this common trend. For each borehole, we selected a representative ‘trend’ channel near the toe where relatively little real temperature variation was expected. For the entire time series of measurements at this channel, we removed the absolute temperature offset (so that the first measurement was 0°C). We then subtracted the trend from each channel in that borehole to get to the final ‘corrected’ result. Following this procedure, the channel selected as the ‘trend’ channel obviously becomes a flat line but we feel this is an acceptable trade given the relatively fine channel spacing (0.25 meters). The resulting, processed dataset shows the various signals much more clearly than the raw data (Figure 7). Users are encouraged to use these bath-calibration corrected data unless they are assessing the validity of our correction scheme.

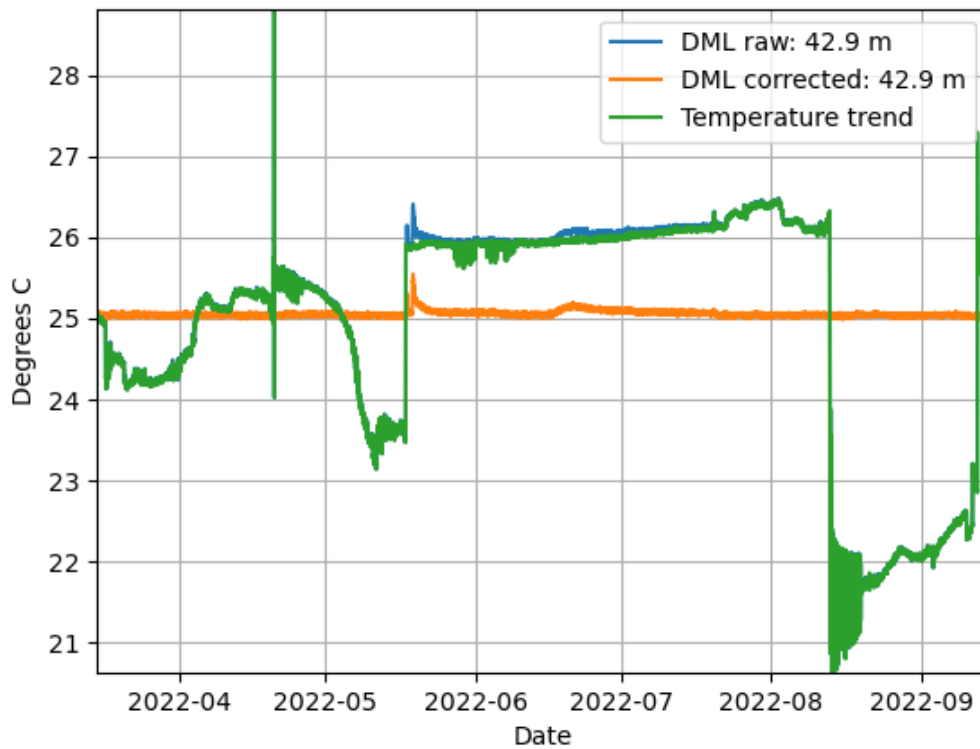

Figure 7: Demonstration of the calibration bath correction described above. Shown are the raw (blue), corrected (orange), and DML temperature trend (green) for the entire time series at a single channel. Green minus blue equals orange and this procedure was applied to each channel in each borehole.

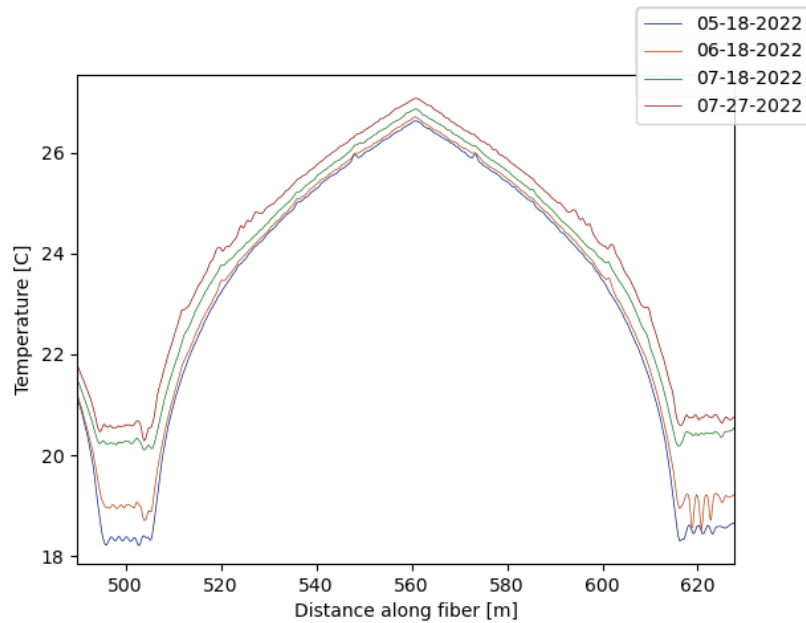

Figure 8: Comparison of the temperatures measured in borehole DML at various times during the circulation test of Experiment 3.

5 Results

The utility of the XT-DTS temperature dataset is twofold. First, it provides a means to locate points along the boreholes where the temperature rapidly changes. These ΔT data are most useful in identifying fracture intersections with the monitoring boreholes. Second, the absolute temperature can be used to calibrate thermo-hydro-mechanical models of the testbed.

5.1 Joule-Thomson effect at fracture intersection points

In the case of the EGS Collab experiments, rapid temperature change occurs most often when a flowing fracture (man-made or otherwise) intersects one of the monitoring boreholes. In this case, through what's known as the Joule-Thomson effect, water heats when depressurized and therefore the DTS system sees a positive change in temperature where pressurized fluid intersects the borehole.

Figure 8 shows this effect at four times during the flow tests of Experiment 3. Under static conditions, the boreholes exhibit a 'smooth' temperature profile, increasing with distance from the drift. The spikes observed at different depths for all time steps in Figure 8 indicate depths where a flowing fracture has intersected this borehole. These features are somewhat ephemeral, as indicated by their presence only during specific periods and not

Borehole	Intersection depth [m]	Start time	End time (approximate)
AMU	34.0	4-12-2022 5:23	4-13-2022 16:00
DML	42.9	5-17-2022 21:24	5-18-2022 5:50
DML	42.9	5-18-2022 22:39	5-22-2022 0:00
DML	43.9	5-18-2022 22:39	5-22-2022 0:00
AMU	54.9	5-24-2022 10:11	6-11-2022 0:00
DML	14.9	5-26-2022 2:13	5-28-2022 0:00
AMU	54.9	6-16-2022 6:00	Unclear
DML	14.9	6-16-2022 21:34	6-19-2022 0:00
DML	42.9	6-17-2022 11:01	Unclear
DML	6.7	7-20-2022 12:36	8-21-2022 12:00
DML	14.9	7-20-2022 12:36	8-21-2022 12:00
DML	22.3	7-20-2022 12:36	8-21-2022 12:00
AML	45.5	8-17-2022 7:16	8-23-2022 0:00
DMU	18.5	7-1-2022	Unclear
DMU	31.0	7-1-2022	Unclear
DMU	43.0	7-1-2022	Unclear

Table 1: Timing and depth of each heating signal observed in the grouted monitoring wells during the entire experiment.

during others. When compiled, these features give a good picture of the spatiotemporal evolution of the flowing fracture network.

Another effective way to visualize these data is to make a so-called ‘waterfall’ plot of the change in temperature relative to the start of data collection for each borehole. Figure 9 shows the change in temperature for each borehole during the chilled water injection tests of EGS Collab experiment 3. All of the Joule-Thomson heating signatures as well as the three ‘cooled’ zones mentioned in the next section are easily identified.

The table below summarizes the location and timing of visually apparent fracture intersections during Experiments 2 and 3. This list is probably not exhaustive and users are encouraged to apply more quantitative methods to identifying temperature changes along these boreholes.

The table above was compiled by visually identifying anomalies in a movie comprised of 6-hourly frames showing the temperature along the entire fiber. Where large (>0.1 °C) temperature fluctuations were noted, we plotted them in more detail to try to determine the exact depth and onset time. Figure 10 shows one such detailed plot showing the first intersection, with borehole AMU, in the table. The arrival of the fracture and decay of the Joule-Thomson heating effect following injection shut-in is evident in the temperature time-series plot in the lower right.

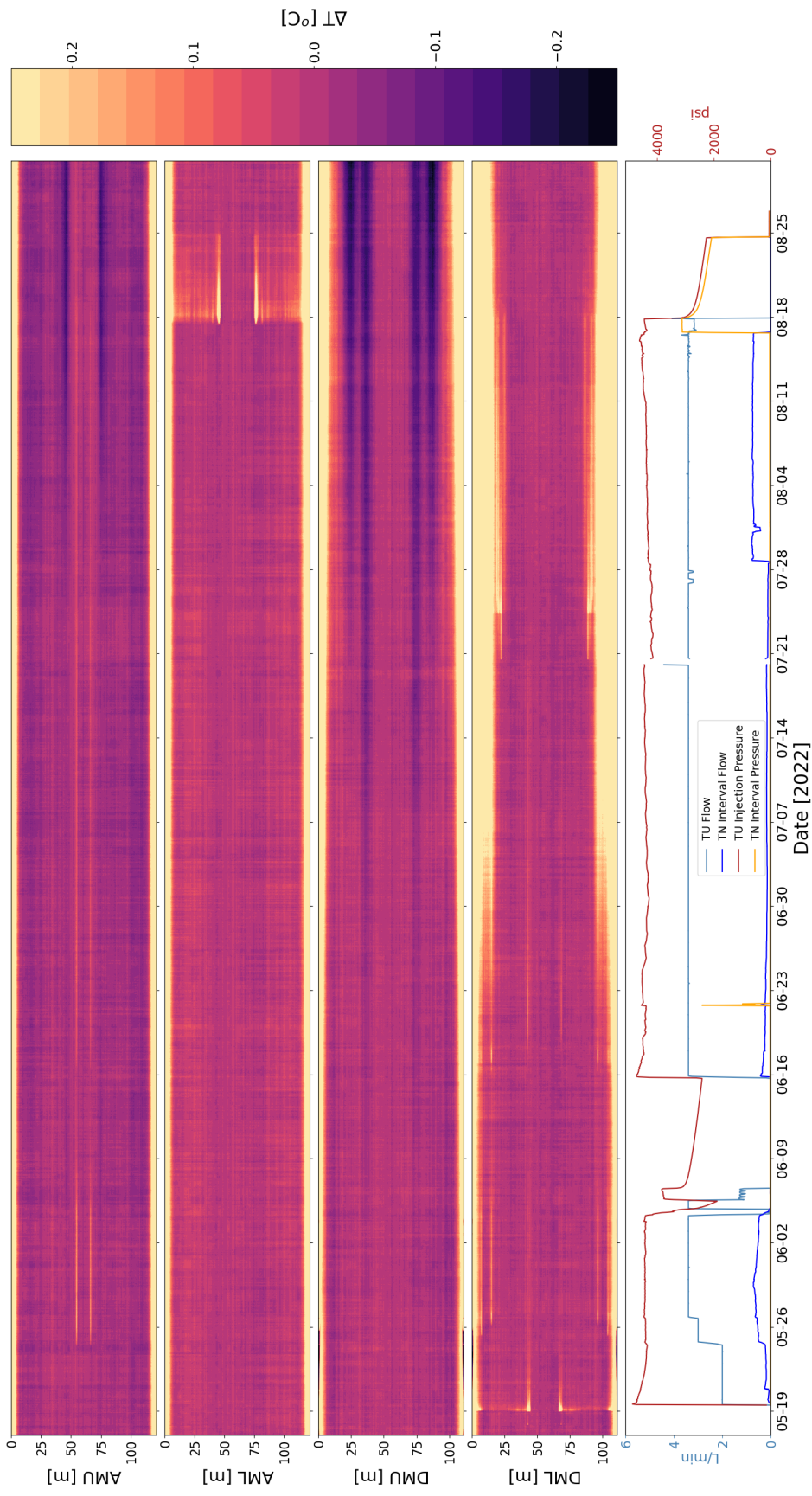

Figure 9: Change in temperature for each of the four grouted monitoring boreholes during the chilled water circulation test. Each panel shows the data for the entire fiber in each borehole (into and back out of the hole). The color scale is ± 0.25 °C.

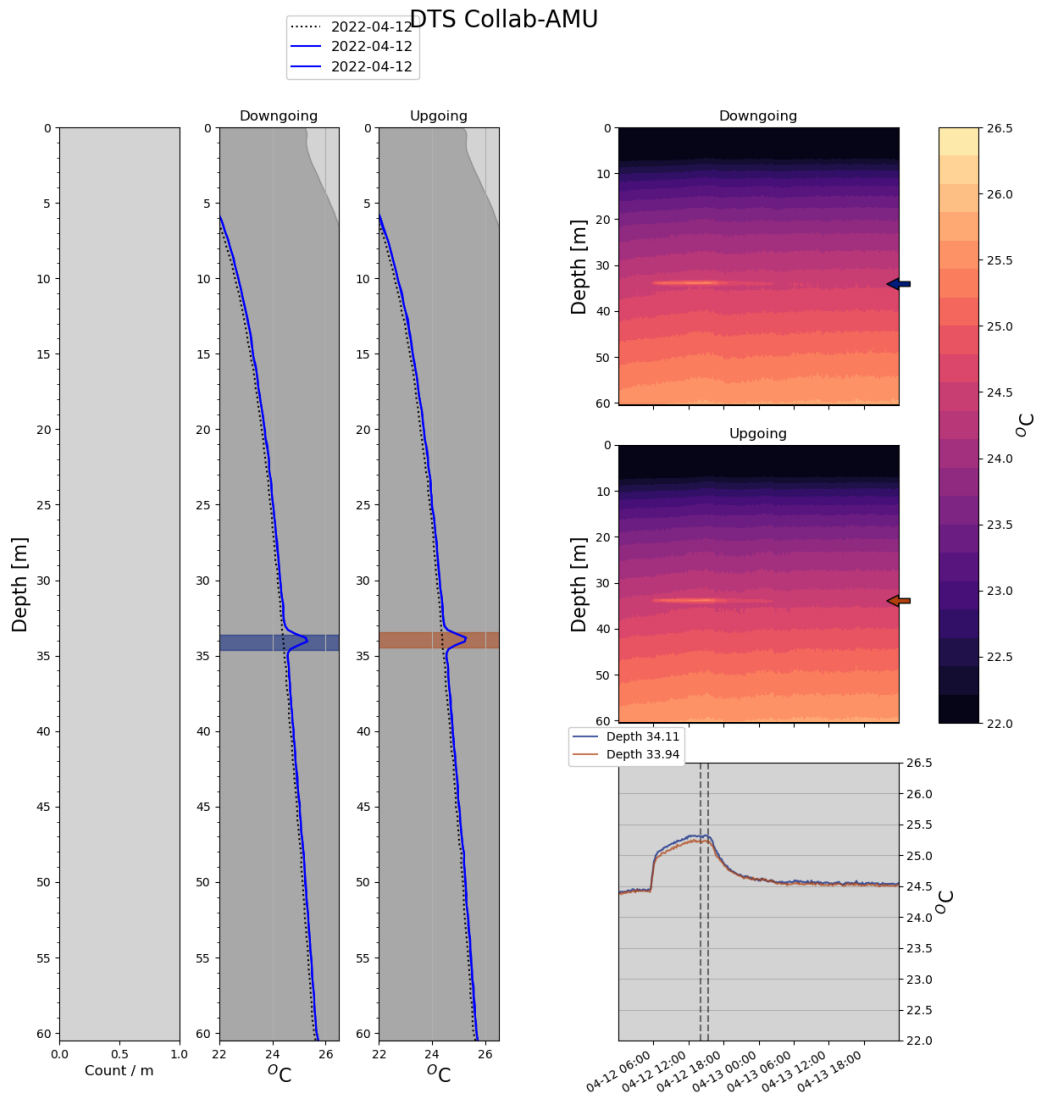

Figure 10: Plot showing the temperature profile along the borehole (left two traces), temperature with time (top right two plots), and the temperature time series at two selected depths (bottom right) for borehole AMU between 4-12-2022 and 4-14-2022.

Borehole	Center-of-interval depth [m]	Start time	Width [m; approx]
DMU	23.7	7-24-2022	10
DMU	36.2	7-7-2022	7
AMU	45.9	7-24-2022	5

Table 2: The table above indicates the depths, approximate onset date, and width of the intervals of cooling along boreholes AMU and DMU during the chilled water injection into TU.

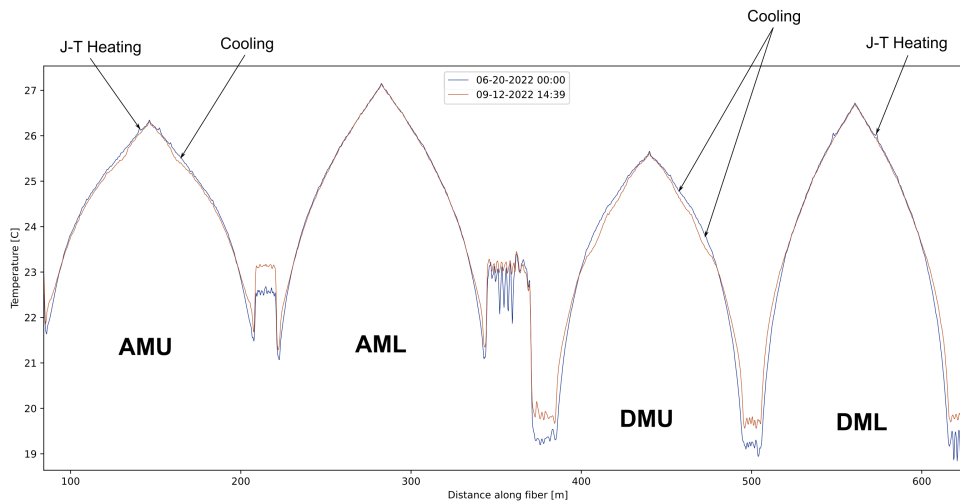

Figure 11: Temperature along fiber on 6-20-2022 (blue) and 9-12-2022 (orange) showing all four boreholes. Locations of Joule-Thomson heating anomalies on 6-20 and cooled zones on 9-12 are indicated.

5.2 Cooling of monitoring boreholes during chilled water circulation

Starting on May 19, 2022, and restarted on June 15, 2022 (following a pump failure), chilled water was injected into borehole TU as part of Experiment 3, aiming to observe a thermal breakthrough at any of the monitoring boreholes. Cooling of the upper, grouted monitoring boreholes (AMU and DMU) was observed starting in early June. The depths and onsets of these zones of cooling are shown in the table below. Figure 11 shows the temperature along fiber for two measurements; one on June 20, 2022, only five days after the restart of chilled water circulation (blue), and the other on September 12, 2022, roughly a month after shut-in of injection (orange). At the indicated sections of AMU and DMU, the orange curve exhibits depressed temperatures of approximately 0.1 °C relative to the blue. Figure 9 also clearly shows the onset and persistence of these features as dark streaks in AMU and DMU during the circulation tests. It is possible that this represents breakthrough of the chilled water with the monitoring boreholes.

5.3 Data access

The data referenced in this report are available on the GDR at this link: <https://gdr.openei.org/submissions/1428>

The repository contains three sets of data:

- Raw data records: Single XML files for each measurement as described above.
- Raw, processed data: Four NetCDF files, one per borehole. These have not been corrected for the calibration bath trend.
- Temperature corrected, processed data: Four NetCDF files, one per borehole. These *have* been corrected for the calibration bath trend (see details above)

References

- [1] Arthur H. Hartog. *An Introduction to Distributed Optical Fibre Sensors*. CRC Press, may 2017.